

OUTLINE DIMENSIONAL DRAWING

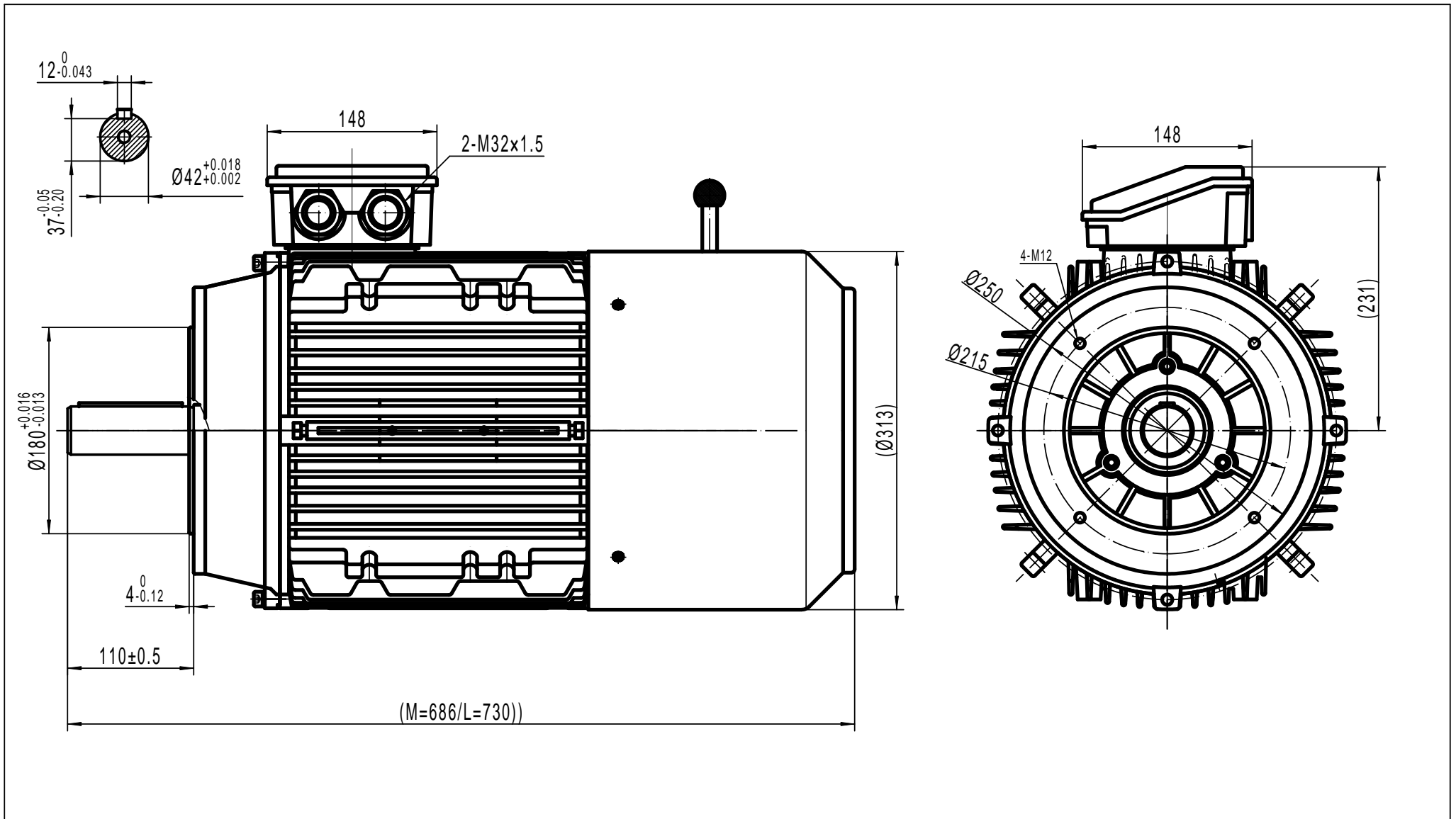

TECHTOP AUSTRALIA PTY LTD	
FRAME	TAIB 160A B14
DATE	DRAWING NO.
2013/10/22	1ST107.060.001-032 A